



# PRODUCTS CATALOG

Programmable Logic Controller  
Human Machine Interface



Addr1:10th Building,E Area,Software Park, Fuzhou,Fujian,China(Manufacturing Center)  
Addr2: 6th Building,F Area,Software Park,Fuzhou,Fujian,China(R & D Center)  
Tel: +86-591-87868869 ext 894 Fax: +86-591-87843899  
Website:www.we-con.com.cn/en  
Email: sales@we-con.com.cn skype:lily-wecon  
Edition No.:WCT3.0.0



2020 Edition

WECON TECHNOLOGY Co.,LTD.All Rights Reserved.

# About WECON

FUZHOU FU CHANG WECON ELECTRONICS TECHNOLOGY CO.,LTD.

WECON Technology Co., Ltd. is a Chinese high technology company, headquartered in Fuzhou software park, Fujian. We independently develop, manufacture, support and sell Human Machine Interface (HMI), Programmable Logic Controller (PLC), Industrial Panel PC (IPC) and V-BOX for Industrial IoT.

Our products are widely used in Machinery, Metallurgy, Chemical, Oil & Gas and other industries. As of May 1st, 2018, WECON has been authorized 47 patents, including 4 utility patents, 41 software intellectual property patents, and 2 appearance patents.

WECON have over 40 domestic offices in major industrial cities, providing technical and sales services to more than 100 agents and numerous terminals throughout the country. Besides domestic market, WECON also expands International market actively. We export products to more than 120 countries and have many distributors such as India, Turkey, Italy, Poland and so on.

**Concept:** Easy Control, Easy Life

**Values:** Specialization, Branding, Internationalization

**Mission:** Creating value for our customers, staffs, suppliers and society

## Culture

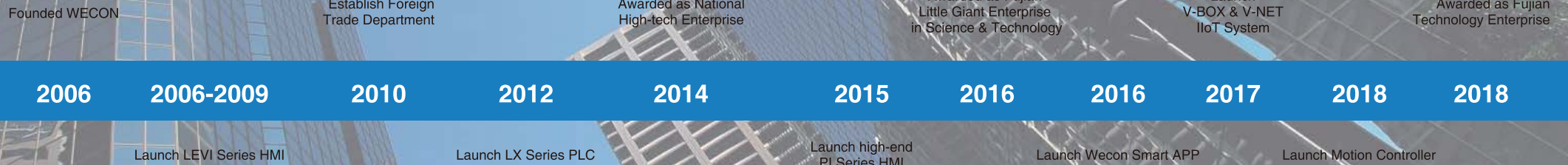

# PI9000 SERIES

Super Size High Resolution

Cortex A9 1.4GHz

Aluminum Body

All Metal Design, with Nobility



TFT

High Definition

High Resolution

16000k colors

Full view LCD screen

1920 x 1080 pixels



# PI8000 SERIES

High-end Configuration

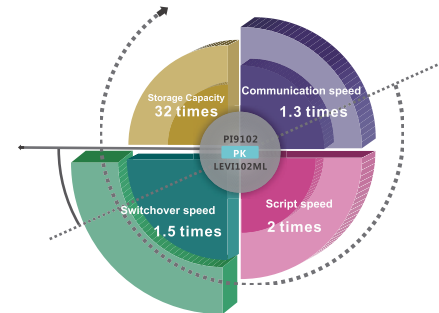

## CORTEX A8 CPU

- Flash 2GB EMMC
- 32GB SD card, 64GB USB Flash Drive supported
- RS232/RS485/RS422 supported
- Ethernet, CANBus, USB2.0 (USB Host; USB Client) port supported

HTML5 as the background language, breaks through the traditional restrictions.



Exquisite Graphics

Rich library of charts ,meters.



Multi-language

Up to 8 language that could be displayed on the screen.



Multi-communication Port

Up to 5 serial ports, Ethernet port ,CAN protocol, Modbus,over 200 protocols supported.



External Devices

Micro-printer, Barcode scanner, WIFI, USB,USB scanner etc.

# INTELLIGENT

## Cloud Platform >>

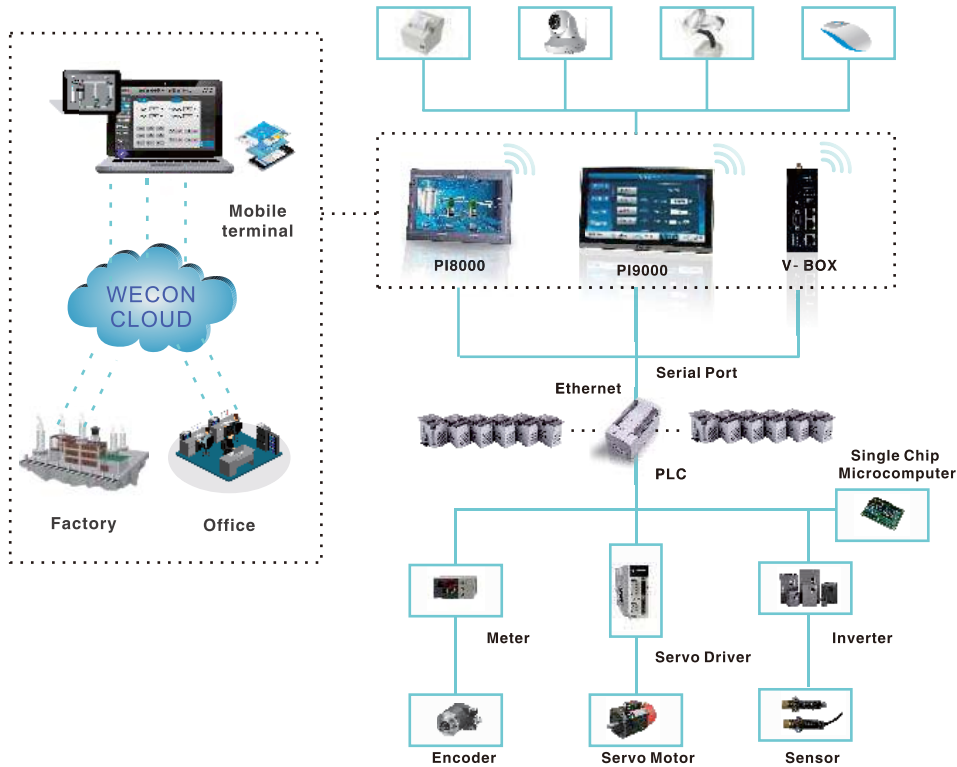

## Cloud Monitoring

Wecon Smart App for Android/iOS devices supports multiple users operating simultaneously on PI 8000/9000 Series HMI.



# SECURITY

## Cloud Message



In case of emergency, notification could be sent to your mobile and you can deal with it immediately.

## Remote Debug over cloud



Through connection over cloud, PLC and HMI could be connected to PC for online debugging and programming.

## Security System >>



### Access Authorization

Access authorization can be set to each button to protect against unauthorized operation or misoperation. Roles are to be assigned to users to facilitate management.



### Operation Record

- To record each step of operations from authorized users.
- Timestamp, buttons pressed and depressed, everything would be logged.
- Log files are stored in database format for data analyzation to improve management.



### Security Management

- Programmer passwords can protect your project from unauthorized access or reverse engineering.
- Project passwords protect your project files against uploading and running on unauthorized HMIs.



### Password Security

Project passwords, access passwords, administration passwords and remote passwords are working together to ensure secure access.



Smart Home



Smart Breeding



Vehicle



Smart Factory



Security

# PI3000i SERIES

## NEW UPGRADE MORE FLUENT TOUCH

- Large capacity library
- Enhance software security
- Less boot time
- Better waterproof & cooling



Faster screen update



Faster screen switch



Better communication stability

### Three models for different demands

PI3070i	7 inch HMI, suitable for general applications.
PI3102i	10.2 inch high resolution HMI, 1024*600 pixels, Ethernet supported.
PI3070i-SL	7 inch open frame HMI, with rear mount installation.
PI3070i-N	Ethernet supported.
PI3070i-N-SL	Ethernet supported.

# PI3000 SERIES

## LAN monitor >>

### A Convenience

- Monitoring software on PC can scan HMI in local area network to add them into the list for monitoring.
- LAN Monitoring Software on PC helps to find available PI3000-O HMI in LAN, and add in monitoring list.

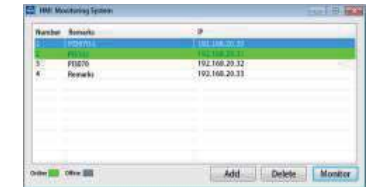

- Real-time synchronization between PC and HMI, ensure the accuracy of data.

### B Security

All traffic is limited in LAN, no access from Internet. Simple and effective software programming, stable performance.

### C Data Collection and Storage

Up to 32G USB Flash Drive and SD card are supported, SQL supported for data querying and analyzation. (Developing)

## PLC Program upgrade by USB Flash Drive >>

Remarks: this function is only for Wecon PLC

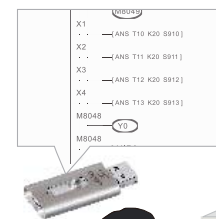

USB Disk Download PLC Program  
( All PI Series supported)

### A Convenience

Convenience in program upgrade without PC and extra data cable.

### B Usability

One USB flash drive can be used to upgrade multiple HMI panels.

### C Security

New program can be encrypted for safety. PLC program would be also encrypted during downloading.

# PI3000i SPECIFICATIONS

## Basic HMI



### Model

PI3070i PI3070i-N PI3102i PI3070i-SL PI3070i-N-SL

OS		Wecon OS based on Linux QT				
CPU		Cortex A7 528MHz				
Touch Screen		High precision four-wire resistive				
Display	Screen Size	7 Inch		10.2 Inch		7 Inch
	Resolution	800*480		1024*600		800*480
	Brightness	250 cd/m <sup>2</sup>		350 cd/m <sup>2</sup>		250 cd/m <sup>2</sup>
	Backlight Type	LED				
	Backlight Life Time	50,000 Hours				
	Colors	16,000k colors				
Storage	Flash	128MB				
	RAM	DDRIII 128MB				
	SD Card	NA				
USB		USB Host: USB 2.0 x 1; USB Client: USB 2.0 x 1				
Ports	Port Number		1 Physical Serial Ports			
	Serial Port (2 in 1)	COM1	RS422 / RS485			
		COM2	RS232			
	Ethernet	N/A	YES	YES	N/A	YES
Permanent Calendar		Built-in				
Power	Power Supply	24V DC(12~28V DC)				
	Power Consumption	< 8W		< 10W		< 8W
Dimension	Enclosure	ABS				
	Dimension(mm)	201.2W*147.2H*39.0D		272.0W*190.0H*41.5D		191.2W*137.2H*41.0D
	Mounting Size (mm)	192.0W*138.0H		260.0W*179.0H		172.0W*111.0H
	Weight (KG)	0.51 / 0.74		1.00 / 1.31		0.52 / 0.74
Environment	Protection	IP65 (Front panel)				
	Temperature	Storage: -20℃~70℃; Working: -10℃~60℃				
	Humidity	10 ~ 85%RH(Non-condensing)				
	Vibration Resistance	IEC61131-2 Standard				
CE Certification		CE Marked				
FCC Certification		FCC Class A				
Programming Software		PI Studio				
Remote Control		N/A				

# PI3000 SPECIFICATIONS

## Basic HMI



### Model

PI3070N PI3102N PI3102H PI3102HE

OS		Wecon OS based on Linux QT				
CPU		Cortex A8 600MHz				
Touch Screen		High precision four-wire resistive				
Display	Screen Size	7 Inch		10.2 Inch		10.2 Inch
	Resolution	800*480		1024*600		1024*600
	Brightness	300 cd/m <sup>2</sup>		350 cd/m <sup>2</sup>		350 cd/m <sup>2</sup>
	Backlight Type	LED				
	Backlight Life Time	50,000 Hours				
	Colors	16,000k colors				
Storage	Flash	128MB				
	RAM	DDRIII 128MB				
	SD Card	Compatible				-
USB		USB Host: USB 2.0 x 1; USB Client: USB 2.0 x 1				
Ports	Port Number		2 Physical Serial Ports			1 Physical Serial Port
	Serial Port	COM1	RS232/RS422/RS485			RS422/RS485
		COM2	RS232/RS485			RS232
		COM3	--			
Ethernet	YES					
Permanent Calendar		Built-in				
Power	Power Supply	24V DC(12~28V DC)				
	Power Consumption	< 10W				
Dimension	Enclosure	ABS				
	Dimension(mm)	200.1W*146.0H*36.5D		271.8W*190.4H*41.2D		
	Mounting Size (mm)	192.0W*138.0H		260.0W*179.0H		
	Weight (KG)	0.6		1.2		
Environment	Protection	IP65 (Front panel)				
	Temperature	Storage: -30℃~70℃; Working: -10℃~60℃				
	Humidity	10 ~ 90%RH(Non-condensing)				
	Vibration Resistance	10~25Hz (X,Y,Z direction 2G/3D minutes)				
CE Certification		CE Marked				
FCC Certification		FCC Class A				
Programming Software		PI Studio				
Remote Control		N/A				

# PI8000 SPECIFICATIONS

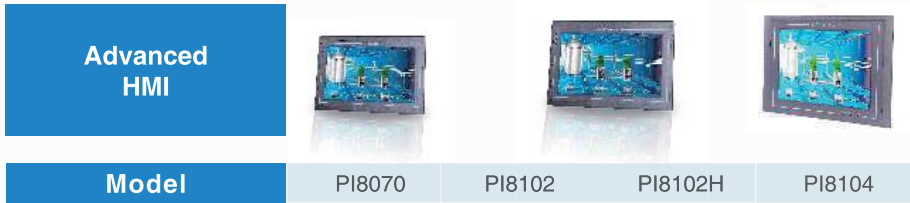

OS		Wecon OS based on Linux QT			
CPU		Cortex A8 600MHz			
Touch Screen		High precision four-wire resistive			
Display	Screen Size	7 Inch	10.2 Inch	10.2 Inch	10.4 Inch
	Resolution	800*480	800*480	1024*600	800*600
	Brightness	300 cd/m <sup>2</sup>	350 cd/m <sup>2</sup>	350 cd/m <sup>2</sup>	300 cd/m <sup>2</sup>
	Backlight Type	LED			
	Backlight Life Time	50,000 Hours			
Storage	Flash	2GB EMMC			
	RAM	DDRIII 512MB			
	SD Card	Compatible			
I/O Ports	USB	USB Host:USB 2.0 x 1 USB Client:USB 2.0 x 1			
	Serial Port	COM1	RS232,RS422/RS485		
		COM2	RS232,RS485		
		COM3	RS485		
	Ethernet	YES			
	CAN	YES			
Permanent Calendar		Built-in			
Power	Power Supply	24V DC(12-28V DC)			
	Power Consumption	<10W			
Dimension	Enclosure	ABS			
	Dimension(mm)	200.1W*146.0H*36.5D	271.8W*190.4H*41.2D		298.0W*223.0H*53.5D
	Mounting Size(mm)	192.0W*138.0H	260.0W*179.0H		288.0W*212.0H
	Weight(KG)	0.6	1.2		1.9
Environment	Protection	IP65 (Front panel)			
	Storage Environment	Storage :-30℃ ~ 70℃; Working: -10℃ ~ 60℃			
	Working Environment	10 ~ 90%RH(Non-condensing)			
	Vibration Resistance	10 ~ 25 Hz (X, Y, Z direction 2G/30 minutes)			
CE Certification		CE Marked			
FCC Certification		FCC Class A			
Software		PI Studio			
Remote Control		Optional			

# PI9000 SPECIFICATIONS



OS		Wecon OS based on Linux QT		
CPU		Cortex A9 1.4GHz		
Touch Screen		High precision four-wire resistive		
Display	Screen Size	12 Inch	15 Inch	
	Resolution	1920*1080		
	Brightness	250 cd/m <sup>2</sup>		
	Backlight Type	LED		
	Backlight Life Time	50,000 Hours		
	Colors	16,000k colors		
Storage	Flash	4GB EMMC		
	RAM	DDRIII 512MB		
	SD Card	Compatible		
I/O Ports	USB	USB Host:USB 2.0 x 1 USB Client:USB 2.0 x 1		
	Serial Port	COM1	RS232, RS422/RS485	
		COM2	RS232, RS485	
		COM3	RS485	
		Ethernet	YES	
Permanent Calendar		Built-in		
Power	Power Supply	24V DC(12-28V DC)		
	Power Consumption	<10W		
Dimension	Enclosure	Aluminum		
	Dimension(mm)	312.6W*208.9H*49.9D	402.9W*253.2H*47.0D	
	Mounting Size(mm)	306.0W*202.0H		
	Weight (KG)	2.2	3.1	
Environment	Protection	IP65 (Front panel)		
	Storage Environment	Storage:-30℃ ~ 70℃; Working: 0℃ ~ 50℃		
	Working Environment	10 ~ 90%RH(Non-condensing)		
	Vibration Resistance	10 ~ 25 Hz (X, Y, Z direction 2G/30 minutes)		
CE Certification		CE Marked		
FCC Certification		FCC Class A		
Software		PI Studio		
Remote Control		Optional		

# LEVI SERIES SPECIFICATIONS

Standard  
HMI



Model	LEVI2035T	LEVI2043T	LEVI2043E	LEVI2043E-N	LEVI2043E-U
-------	-----------	-----------	-----------	-------------	-------------

General	Screen Size	3.5 Inch	4.3 Inch	4.3 Inch	4.3 Inch	4.3 Inch
	Resolution	320*240	480*272	480*272	480*272	480*272
	Colors	260k colors				
	Brightness	400 cd/m <sup>2</sup>				
	Backlight Type	LED				
	Touch Screen	High precision four-wire resistive				
	Backlight Life Time	50,000 hours				
	CPU	32-bits 300MHz RISC				
	Storage	128M FLASH + 128M DDRAM				
	RTC	256KB+real time clock				
	Printer Port	Serial Port Printer				
	USB Port	Micro-USB	USB	Micro-USB	Micro-USB	Micro-USB
	SD Card	--				
	Serial Port (2 in 1)	COM1	RS422/RS485			
COM2		RS232				
Power	Rated Power	< 5W				
	Power Supply	DC24V (12 ~ 28V DC)				
	Allowed Power Fail	< 5ms				
	Insulation	>20MΩ 500VDC				
Withstand Voltage	500V AC <1 minute					
Dimension	Enclosure	ABS, Black				
	Dimension (mm)	96.0W*81.0H*33.0D	141.4W*85.4H*38.9D	141.0W*86.0H*30.3D		
	Mounting Size	91.0W* 73.0H	131.0W*79.0H	131.0W* 78.0H		
	Net / Gross (KG)	0.14/0.26	0.23 / 0.39	0.19/0.30		
Environment	Temperature	Working Temperature : -10 ~ 60°C ; Storage Temperature : -20 ~ 70°C				
	Humidity	10 ~ 85%RH (Non-condensing)				
	Vibration	10 ~ 25 Hz (X, Y, Z direction 2G/30 minutes)				
	Cooling	Air Cooling				
Extension	Ethernet	--	--	--	YES	YES
Protection		IP65 ((Front panel))				
CE Certification		CE Marked	CE Marked	CE Marked	CE Marked	cULus Listed
FCC Certification		FCC Class A				

# LEVI SERIES SPECIFICATIONS

Standard  
HMI



Model	LEVI2070D	LEVI700ML	LEVI102ML
-------	-----------	-----------	-----------

General	Screen Size	7 Inch	7 Inch	10.2 Inch
	Resolution		800*480	
	Colors	260k colors		
	Brightness	300cd/m <sup>2</sup>		
	Backlight Type	LED		
	Touch Screen	High precision four-wire resistive		
	Backlight Life Time	50,000 hours		
	CPU	32-bits 300MHz RISC		
	Storage	128M FLASH + 128M DDRAM		
	RTC	256KB		
	Printer Port	Serial port Printer		
	USB Port	USB Host + USB Client		
	SD Card	--		
	Serial Port (2 in 1)	COM1	RS422/RS485	
COM2		RS232		
Power	Rated Power	< 8W		
	Power Supply	DC24V (12 ~ 28V DC)		
	Allowed Power Fail	< 5ms		
	Insulation Resistance	> 20MΩ 500V DC		
Withstand Voltage	500V AC <1 minute			
Dimension	Enclosure	Grey, PC+ABS	ABS,Black	ABS,Black
	Dimension (mm)	201.0W*147.0H*39.0D	201.0W*146.0H*36.0D	271.8W*190.4H*41.2D
	Mounting Size (mm)	192.0W*138.0H	192.0W*138.0H	260.0W*179.0H
	Net / Gross (KG)	0.5 /0.74	0.56 /0.80	1.04 /1.37
Environment	Temperature	Working Temperature : -10 ~ 60°C ; Storage Temperature : -20 ~ 70°C		
	Humidity	10 ~ 85%RH (Non-condensing)		
	Vibration Resistance	10 ~ 25 Hz (X, Y, Z direction 2G/30 minutes)		
	Cooling	Air cooling		
Protection		IP65 (Front panel)		
CE Certification		CE Marked		
FCC Certification		FCC Class A		



# PROGRAMMABLE LOGIC CONTROLLER

## PLC Introduction

1. Universal Power Supply Design —85~264V AC 50/60 HZ, wide range power supply.
2. All core components used are from well-known global brands.
3. The 'Three layer coating' ensures the reliability in harsh environment.
4. Flash memory data storage.
5. 200 KHz high speed.
6. Com port – 600 TVS, static surge protection.
7. RS485 communication port ensures the reliability of communication in vibration.
8. Reliable and stable high speed USB port for programming download/monitor.

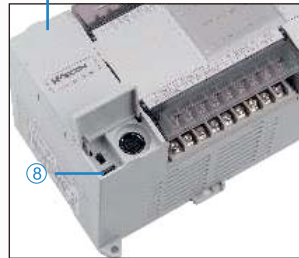

## High Speed Pulse Input

- External high speed pulse input supports Encoder (AB phase) input, pulse + direction mode input; Maximum support for 200 KHz pulse signal input.
- AB phase signal can support configurable frequency settings (i.e. x1, x2 or x4).

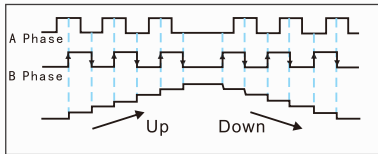

2-doubling

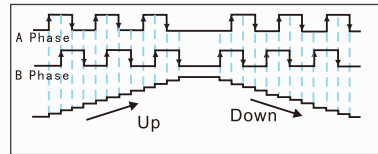

4-doubling

## High Speed Pulse Output

- Supports high speed pulse signal output with acceleration and deceleration.
- The acceleration and deceleration time are configurable.
- Pulse modulation output one by one.

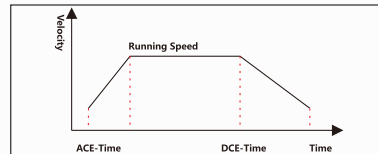

## Program Encryption

It prevents users from illegal copy and tamper of the program.

### Subprogram Encryption

Partial encryption function of the ladder diagram can be realized, and it can encrypt subprograms and interrupts. This function enables protection of important subprogram segment. By choosing the subprogram and setting the password, it can be encrypted. Once it has been encrypted than the subprogram is in "subprogram encryption" state and the encrypted contents will not be displayed.

### Ladder Encryption Methods

The PLC encryption includes project encryption, upload password and download password. All of those passwords can be used for the entire ladder program.

All these kinds of passwords are independent from each other (user need to set password separately during each of these operations), the password can be same or different to ensure copyright of PLC program.



# PROGRAMMABLE LOGIC CONTROLLER

## PLC Host and Program Encryption

For additional protection of the program, project building can be dedicated to the specified PLC model. PLC identification code and program identification code can be introduced. User can set the program identification code of the project and also can set a PLC identification code for the PLC. So, the software will compare the program identification code and PLC identification code at every attempt of the upload or download of the program and can be executed to only designated PLC.

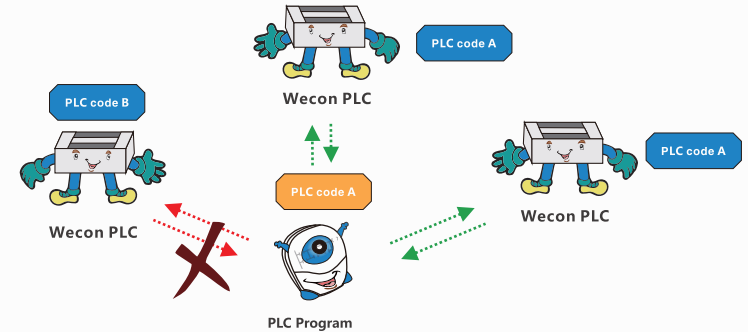

## Modbus Listed Instruction

In the original MODBUS protocol, users must program RS instruction in ladder. But the editing process is quite cumbersome and imperfect. With the help of new method (RSLIST+RSLIST communication list), it becomes easier.

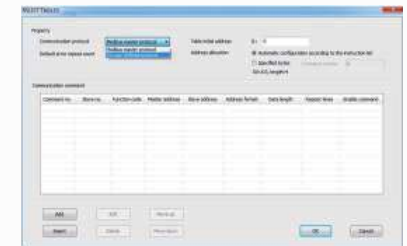

## Features of PLC Wizard Function

- Modules monitor function guides the user to monitor the BFM data in real time. This function reduces customer dependency on module manuals.
- It guides the user to generate the ladder program with the corresponding content (i.e. instruction, modules, BD board, etc.). It saves customer's comprehension time and reduces error which may occur while editing ladder. Also it will help the user to create functioning ladder more quickly.

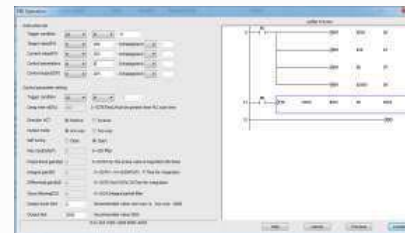

PID Operation Wizard Setting

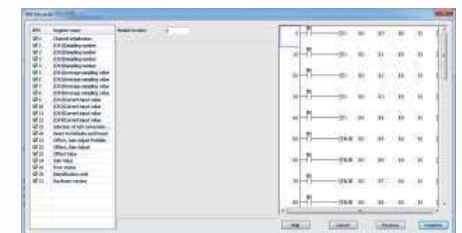

LX-4AD Module Wizard Setting

## APPLICATION

### PLC LX3VP Series >>

- Supports 4 independent channels of 200 KHz high speed pulse output simultaneously. The maximum frequency for each channel is 200 KHz (either in acceleration or deceleration).
- Supports 64 K step ladder diagram.
- Supports N:N PLC network up to 8 PLCs.
- T50~T191 can be converted to 1 ms non-cumulative timer by using special function register M8028.

**Printing machine** includes several parts, including the front edge deliver component segment (with several printing segment), slot and dice segment. By using N:N communication protocol, several PLCs can communicate with each other which improves production efficiency significantly.



### PLC LX3VE Series >>

- Up to 4 channels each of 200 KHz high speed pulse outputs are supported, all 4 channels can work simultaneously.
- Supports 32k steps ladder diagram.
- Supports electronic CAM.
- Supports flying cut and rotary cut.
- Supports jitter pulse output.
- Supports S-type curve to meet special demands.

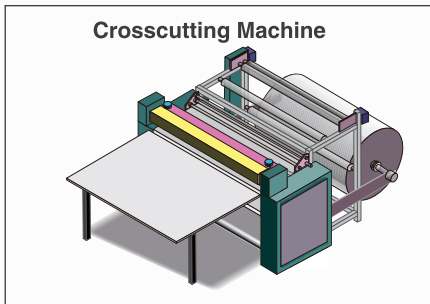

**Crosscutting machine** belongs to carton processing machinery. The crosscutting machine is used in the production line of the corrugated board. It is used for the cutting of the finished cardboard. The technical feature and equipment adjustment status directly affects the accuracy of the finished cardboard's cutting sizes and the appearance of the pressure line.

### PLC LX3VM Series >>

- Up to 4 channels independent 200 KHz high speed pulse output are supported, 4 channels can be used simultaneously.
- Supports 32k steps ladder diagram.
- Three axis liner interpolation (Y0,Y1,Y2) and two axis circular interpolation are supported(Y0,Y1).
- Supports electronic CAM.
- Supports Jitter pulse output.



**Side Cutting Machine** is a CNC machine for punching of holes in the side of the plate type furniture. It is suitable for horizontal hole machining and horizontal slotting. It has features like, Infrared automatic induction, accurate detection of the hole position, accurate movement distance, low error, simple operation, eliminate the need of skilled workers, convenient and efficient.

## APPLICATION

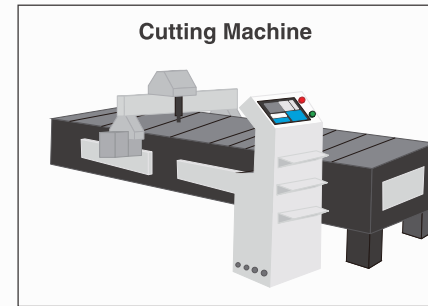

Through the linear-circle interpolation function, the cutting machine realizes the multi axis path positioning control, improves cutting efficiency, quality and relieves the working intensity.

### LX3V-2WT >>

- 2 channels weighing signal input.
- Hardware 24-bit AD input (2: 24-bit Resolution).
- Support 1~2400 Hz frequency conversion speed.
- Adjustable setting of Digital filter.
- Adjustable setting of Tare weight and Net weight.

**Screw packaging machine** is a typical equipment for vibrating plate feeding, screw weighing and packaging. It is difficult to count the actual number of screws dropped down from plate by optical bit counter because of the irregular shape of the object to be weighed. Therefore, it is divided into multistage speed to control the vibration of the feeding plate, it uses the round up and round down (half adjust) to complete counting process. The first part uses the weight measurement, the second part uses the number to compare whether the set weight is achieved.

### LX3V-4LTC >>

LX3V-4LTC is temperature control module, it has four temperature input ports and four transistor output ports (open collector). It reads data from the thermocouple, and give output value with PID control algorithm.

**Battery Drying Oven**, its working process includes warming – cooling – vacuum – forcing – nitrogen filling. The project has total 100 processes comprises two different process cycles. Data monitoring, data acquiring, PID Auto-tuning (self-tuning). Measurement of Temperature at different 12 points. There difference in the temperature at upper, lower, middle, center of the oven. So, temperature gradient is there and homogeneity of the oven is affected.

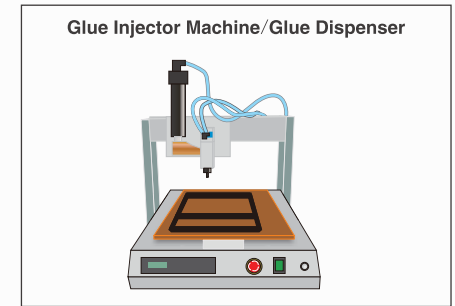

**Glue injector machine** realizes multi-axis path positioning control through linear arc interpolation function and operate it according to the set path. It can be set to semi-automatic, fully automatic, or adjustment modes.

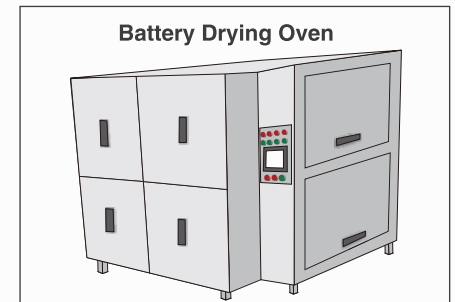

# EXPANSION MODULE

## PLC EXPANSION MODULE

- Multi-module connection :**  
 Support up to 16 modules, 256 input points and 256 output points.  
 Due to the difference plc model, user need to calculate the power consumption at first.
- DA module resolution :12 bits**
- PT/TC module resolution**  
 S-type sensor:-50~+1768 (degree centigrade)  
 R-type sensor:-50~+1768 (degree centigrade)  
 B-type sensor:+250~+1820 (degree centigrade)  
 N-type sensor:-200~+1300 (degree centigrade)  
 E-type sensor:-200~+1000 (degree centigrade)  
 T-type sensor:-200~+400 (degree centigrade)  
 J-type sensor: -210~+600 (degree centigrade)  
 K-type sensor:-200~+1372 (degree centigrade)  
 Pt100 sensor:-100~+600 (degree centigrade)



- AD module resolution :16 bits**
- WT module resolution :24 bits**

## LX3V-8iTC

- 8 channels for temperature acquiring; Multiple sensor types are supported; Supports thermocouple types like K, S, E, N, B, T, J and R.
- All 8 channels are isolated each other.
- Built-in cold junction compensation, external cold junction compensation, freezing cold junction compensation method.

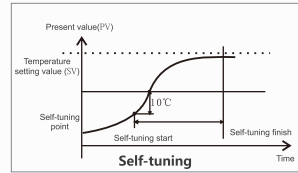

## LX3V-4PGA

- Supports 4-channel high speed pulse outputs.
- Supports zero point return, JOG, interrupt position and two-speed pulse control.
- Supports S-type acceleration and deceleration.
- Maximum supports for 200k pulse output.
- Interrupt signal, origin signal input.

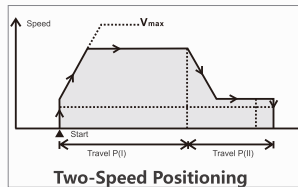

## LX3V-2WT

- 2 channels weighing signal input.
- Hardware 24-bits AD input (2: 24-bit Resolution).
- Supports 1~2400 Hz frequency conversion.
- Adjustable setting of Digital filter.
- Adjustable setting of Tare weight and Net weight.
- Zero-tracking can reduce the influence of temperature drift effective.

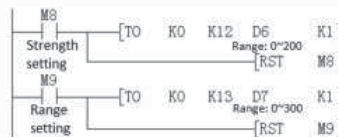

# BD MODULE

## Analog BD BOARD

Multiple Mixed

Low Cost

Small Size

Two BD-board access (Analog Module + Communication module)



Model	Resolution	Input/Output Range	Data Range
DA	12	Output Current : 4~20mA	0~2000
AD	12	Input Current : 4~20mA	0~2000
PT	14	Sensor:PT100-100~600°C	-1000~6000
TC	14	Sensor:Ktype-100~1200°C	-1000~12000
TC	14	Sensor:Jtype-100~600°C	-1000~6000
DAV	12	Output Voltage:-10~10V	-2000~2000
ADV	12	Input Voltage:-10~10V	-2000~2000

## Communication Expansion Board

### LX3V-2RS485-BD



LX3V-2RS485-BD can add two additional RS485 communication ports.

- Data transfer without protocol  
It supports all type of devices with RS-485 communication without protocol. e.g. bar code reader and printer. Data's sending and receiving is implemented by the RS instruction.
- Special protocol for data transferring  
Using a special protocol, data transmission can be possible based on 1: N on RS-485 communication.

### LX3VP-ETH-BD



By using LX3VP-ETH-BD, Ethernet port can be added.

- Supports Modbus-Tcp protocol.
- Maximum 8 devices can be connected (no master-slave) to one LX3VP-EH-BD module.

### LX3VP-CAN Communication ( Only some models of 3VP supported [LX-3VP2416 Mix supported] )

- For Good real-time communication, strong correction ability and stable communication.
- Supports CANopen standard protocol DS301 V4.02.
- Supports 16 slave devices when used as master.
- Free configuration by using CANopen network configuration software "CANopen Tool".
- It works as a master or a slave.

# LX3V SERIES PLC PRODUCT

## LX3V Series



PLC Model	I/O	Output type	Dimension (mm)	Pulse Counter	Pulse Output	RS485	BD Board	Module	Power Supply
LX3V-0806MR-A1(D1)	8/6	Relay	75x107x87	2	0	1	1	N/A	AC ( DC )
LX3V-0806MT-A1(D1)	8/6	Transistor	75x107x87	2	2	1	1	N/A	AC ( DC )
LX3V-0806MR-A2(D2)	8/6	Relay	75x107x87	2	0	1	1	N/A	AC ( DC )
LX3V-0806MT-A2(D2)	8/6	Transistor	75x107x87	2	2	1	1	N/A	AC ( DC )
LX3V-1208MR-A1(D1)	12/8	Relay	75x107x87	2	0	1	1	N/A	AC ( DC )
LX3V-1208MT-A1(D1)	12/8	Transistor	75x107x87	2	2	1	1	N/A	AC ( DC )
LX3V-1208MR-A2(D2)	12/8	Relay	75x107x87	2	0	1	1	N/A	AC ( DC )
LX3V-1208MT-A2(D2)	12/8	Transistor	75x107x87	2	2	1	1	N/A	AC ( DC )
LX3V-1208MR2H-A2(D2)	12/8	Mix	75x107x87	2	2	1	1	N/A	AC ( DC )
LX3V-1212MR-A(D)	12/12	Relay	137x107x87	2	0	2	1	YES	AC ( DC )
LX3V-1212MT-A(D)	12/12	Transistor	137x107x87	2	2	2	1	YES	AC ( DC )
LX3V-1212MT4H-A(D)	12/12	Transistor	137x107x87	2	4	2	1	YES	AC ( DC )
LX3V-1212MR2H-A(D)	12/12	Mix	137x107x87	2	2	2	1	YES	AC ( DC )
LX3V-1412MR-A(D)	14/12	Relay	137x107x87	2	0	2	1	YES	AC ( DC )
LX3V-1412MT-A(D)	14/12	Transistor	137x107x87	2	2	2	1	YES	AC ( DC )
LX3V-1412MT4H-A(D)	14/12	Transistor	137x107x87	2	4	2	1	YES	AC ( DC )
LX3V-1412MR2H-A(D)	14/12	Mix	137x107x87	2	2	2	1	YES	AC ( DC )
LX3V-1616MR-A(D)	16/16	Relay	175x107x87	2	0	2	2	YES	AC ( DC )
LX3V-1616MT-A(D)	16/16	Transistor	175x107x87	2	2	2	2	YES	AC ( DC )
LX3V-1616MT4H-A(D)	16/16	Transistor	175x107x87	2	4	2	2	YES	AC ( DC )
LX3V-1616MR2H-A(D)	16/16	Mix	175x107x87	2	2	2	2	YES	AC ( DC )
LX3V-2416MR-A(D)	24/16	Relay	175x107x87	2	0	2	2	YES	AC ( DC )
LX3V-2416MT-A(D)	24/16	Transistor	175x107x87	2	2	2	2	YES	AC ( DC )
LX3V-2416MT4H-A(D)	24/16	Transistor	175x107x87	2	4	2	2	YES	AC ( DC )
LX3V-2416MR2H-A(D)	24/16	Mix	175x107x87	2	2	2	2	YES	AC ( DC )
LX3V-2424MR-A(D)	24/24	Relay	220x107x87	2	0	2	2	YES	AC ( DC )
LX3V-2424MT-A(D)	24/24	Transistor	220x107x87	2	2	2	2	YES	AC ( DC )
LX3V-2424MT4H-A(D)	24/24	Transistor	220x107x87	2	4	2	2	YES	AC ( DC )
LX3V-2424MR2H-A(D)	24/24	Mix	220x107x87	2	2	2	2	YES	AC ( DC )
LX3V-3624MR-A(D)	36/24	Relay	220x107x87	2	0	2	2	YES	AC ( DC )
LX3V-3624MT-A(D)	36/24	Transistor	220x107x87	2	2	2	2	YES	AC ( DC )
LX3V-3624MT4H-A(D)	36/24	Transistor	220x107x87	2	4	2	2	YES	AC ( DC )
LX3V-3624MR2H-A(D)	36/24	Mix	220x107x87	2	2	2	2	YES	AC ( DC )

# LX3VP SERIES PLC PRODUCT

## LX3VP Series



PLC Model	I/O	Output type	Dimension (mm)	Pulse Counter	Pulse Output	RS485	CAN	BD Board	Module	Power Supply
LX3VP-1208MR-A(D)	12/8	Relay	75x107x87	2	0	1	N/A	1	N/A	AC ( DC )
LX3VP-1208MT-A(D)	12/8	Transistor	75x107x87	2	2	1	N/A	1	N/A	AC ( DC )
LX3VP-1212MR-A(D)	12/12	Relay	137x107x87	2	0	2	N/A	1	YES	AC ( DC )
LX3VP-1212MT-A(D)	12/12	Transistor	137x107x87	2	2	2	N/A	1	YES	AC ( DC )
LX3VP-1212MT4H-A(D)	12/12	Transistor	137x107x87	2	4	2	N/A	1	YES	AC ( DC )
LX3VP-1212MR2H-A(D)	12/12	Mix	137x107x87	2	2	2	N/A	1	YES	AC ( DC )
LX3VP-1412MR-A(D)	14/12	Relay	137x107x87	2	0	2	N/A	1	YES	AC ( DC )
LX3VP-1412MT-A(D)	14/12	Transistor	137x107x87	2	2	2	N/A	1	YES	AC ( DC )
LX3VP-1412MT4H-A(D)	14/12	Transistor	137x107x87	2	4	2	N/A	1	YES	AC ( DC )
LX3VP-1412MR2H-A(D)	14/12	Mix	137x107x87	2	2	2	N/A	1	YES	AC ( DC )
LX3VP-1616MR-A(D)	16/16	Relay	175x107x87	2	0	2	N/A	2	YES	AC ( DC )
LX3VP-1616MT-A(D)	16/16	Transistor	175x107x87	2	2	2	N/A	2	YES	AC ( DC )
LX3VP-1616MT4H-A(D)	16/16	Transistor	175x107x87	2	4	2	N/A	2	YES	AC ( DC )
LX3VP-1616MR2H-A(D)	16/16	Mix	175x107x87	2	2	2	N/A	2	YES	AC ( DC )
LX3VP-2416MR-A(D)	24/16	Relay	175x107x87	2	0	2	Optional	2	YES	AC ( DC )
LX3VP-2416MT-A(D)	24/16	Transistor	175x107x87	2	2	2	Optional	2	YES	AC ( DC )
LX3VP-2416MT4H-A(D)	24/16	Transistor	175x107x87	2	4	2	Optional	2	YES	AC ( DC )
LX3VP-2416MR2H-A(D)	24/16	Mix	175x107x87	2	2	2	Optional	2	YES	AC ( DC )
LX3VP-2424MR-A(D)	24/24	Relay	220x107x87	2	0	2	N/A	2	YES	AC ( DC )
LX3VP-2424MT-A(D)	24/24	Transistor	220x107x87	2	2	2	N/A	2	YES	AC ( DC )
LX3VP-2424MT4H-A(D)	24/24	Transistor	220x107x87	2	4	2	N/A	2	YES	AC ( DC )
LX3VP-2424MR2H-A(D)	24/24	Mix	220x107x87	2	2	2	N/A	2	YES	AC ( DC )
LX3VP-3624MR-A(D)	36/24	Relay	220x107x87	2	0	2	N/A	2	YES	AC ( DC )
LX3VP-3624MT-A(D)	36/24	Transistor	220x107x87	2	2	2	N/A	2	YES	AC ( DC )
LX3VP-3624MT4H-A(D)	36/24	Transistor	220x107x87	2	4	2	N/A	2	YES	AC ( DC )
LX3VP-3624MR2H-A(D)	36/24	Mix	220x107x87	2	2	2	N/A	2	YES	AC ( DC )

# LX3VE&3VM SERIES PLC PRODUCT

## LX3VE Series



PLC Model	I/O	Output type	Dimension (mm)	Pulse Counter	E-CAM	Pulse Output	RS485	BD Board	Module	Power Supply
LX3VE-1412MT-A	14/12	Transistor	137x107x87	2	YES	2	2	1	YES	AC(DC)
LX3VE-1412MT4H-A	14/12	Transistor	137x107x87	2	YES	4	2	1	YES	AC(DC)
LX3VE-1616MT-A	16/16	Transistor	175x107x87	2	YES	2	2	2	YES	AC(DC)
LX3VE-1616MT4H-A	16/16	Transistor	175x107x87	2	YES	4	2	2	YES	AC(DC)
LX3VE-2416MT-A	24/16	Transistor	175x107x87	2	YES	2	2	2	YES	AC(DC)
LX3VE-2416MT4H-A	24/16	Transistor	175x107x87	2	YES	4	2	2	YES	AC(DC)
LX3VE-2424MT-A	24/24	Transistor	220x107x87	2	YES	2	2	2	YES	AC(DC)
LX3VE-2424MT4H-A	24/24	Transistor	220x107x87	2	YES	4	2	2	YES	AC(DC)
LX3VE-3624MT-A	36/24	Transistor	220x107x87	2	YES	2	2	2	YES	AC(DC)
LX3VE-3624MT4H-A	36/24	Transistor	220x107x87	2	YES	4	2	2	YES	AC(DC)

## LX3VM Series



PLC Model	I/O	Output type	Dimension (mm)	Pulse Counter	E-CAM	Interpolation	Pulse Output	RS485	BD Board	Module	Power Supply
LX3VM-1412MT-A	14/12	Transistor	137x107x87	2	YES	YES	2	2	1	YES	AC(DC)
LX3VM-1412MT4H-A	14/12	Transistor	137x107x87	2	YES	YES	4	2	1	YES	AC(DC)
LX3VM-1616MT-A	16/16	Transistor	175x107x87	2	YES	YES	2	2	2	YES	AC(DC)
LX3VM-1616MT4H-A	16/16	Transistor	175x107x87	2	YES	YES	4	2	2	YES	AC(DC)
LX3VM-2416MT-A	24/16	Transistor	175x107x87	2	YES	YES	2	2	2	YES	AC(DC)
LX3VM-2416MT4H-A	24/16	Transistor	175x107x87	2	YES	YES	4	2	2	YES	AC(DC)
LX3VM-2424MT-A	24/24	Transistor	220x107x87	2	YES	YES	2	2	2	YES	AC(DC)
LX3VM-2424MT4H-A	24/24	Transistor	220x107x87	2	YES	YES	4	2	2	YES	AC(DC)
LX3VM-3624MT-A	36/24	Transistor	220x107x87	2	YES	YES	2	2	2	YES	AC(DC)
LX3VM-3624MT4H-A	36/24	Transistor	220x107x87	2	YES	YES	4	2	2	YES	AC(DC)

# MODULE&BD MODULE PRODUCT



## PLC Expansion Module



Module	Specification	Module	Specification
LX3V-8EX	8 Input	LX3V-2WT	2 * Weighting(24-bit)
LX3V-8EYR	8 Relay Output	LX3V-2WT-L	2 * Weighting(16-bit)
LX3V-8EYT	8 Transistor Output	LX3V-4AD	4 * Analog Input
LX3V-16EX	16 Input	LX3V-4DA	4 * Analog Output
LX3V-16EYR	16 Relay Output	LX3V-4PT	4 * Thermal Resistance Input
LX3V-16EYT	16 Transistor Output	LX3V-4TC	4 * Thermocouple Input
LX3V-1WT	1 * Weighting(24-bit)	LX3V-4LTC	4 * TC with Isolation (PID Control)
LX3V-1WT-L	1 * Weighting(16-bit)	LX3V-8ITC	8*Thermocouple Input
LX3V-4PGA	4* pulse generator (Advanced)	LX3V-4PGB	4* pulse generator (Basic)
LCM-16EX	16 Input, supports RS485 Modbus communication	LCM-16EYR	16 Relay Output, supports RS485 Modbus communication.
LCM-4TC	4*thermocouple Input, supports RS485 Modbus communication.	LCM-2WT	2*weighting expansion module, 24-bit resolution, supports RS485 Modbus communication.

## PLC BD Module



BD Board	Function	BD Board	Function
LX3V-2ADI2DAI-BD	2 * Analog Input/ Analog Output (4~20mA)	LX3V-2PT-BD	2 * Thermal Resistance Input
LX3V-2TC2DAI-BD	2 * Thermocouple Input; 2 * Analog Output (4~20mA)	LX3V-2PT2ADV-BD	2 * Thermal Resistance Input; 2 * Analog Voltage input(-10v-10v)
LX3V-2PT2DAI-BD	2 * Thermal Resistance Input; 2 * Analog Output (4~20mA)	LX3V-2PT2DAV-BD	2 * Thermal Resistance Input; 2 * Analog Voltage Output(-10v-10v)
LX3V-2TC-BD	2 * Thermocouple Input	LX3V-2ADV2DAV-BD	2 * Analog Input/ Output (-10V~10V)
LX3V-4ADI-BD	4 * Analog Input (4~20mA)	LX3V-2RS485-BD	2 * RS485 Communication
LX3V-4ADV-BD	4 * Analog Input (-10V~10V)	LX3V-ETH-BD	1 * Ethernet Communication
LX3V-2ADV-BD	2*Analog Voltage Input(-10v-10v)	LX3V-2DAI-BD	2*Analog Current Output(4~20mA)
LX3V-2ADI-BD	2*Analog Current Input(4~20mA)	LX3V-2DAV-BD	2*Analog Voltage Output(-10v-10v)
LX3V-2PTS-BD			2* Thermal Resistance Input, Precision >0.1℃

# PLC SPECIFICATIONS

## General



	LX3V Series	LX3VP Series	LX3VE/3VM Series
Running Mode	Round Scan/Interrupt		
Programming	Instruction List/Ladder		
Total Instructions	Basic Instructions:27/Applied Instruction:138		140
Execute time	Basic Instructions:0.06us/Applied Instruction:1~10us		
System Storage	16K	64K	32K
Download/Monitoring	Serial Programming Cable/MiniUSB		
High Speed Pulse Output	Transistor: 2 channels(4 channel optional)/Relay N/A(2 channel optional)		
External Interrupt	6 Channels		
Timer Interrupt	3 Channels		
Holding Addresses	Adjustable		
Storage	FLASH		
Filter	For all X input terminals		
Serial Port	COM1 : RS422 or RS485 COM2 : RS485		
Temperature	Working Temperature : 0~55°C/ Storage Temperature : 0~70°C		
Humidity	35~85%RH ( Without condensation )		
Shock Resistance	JISC0040 Standard		
Influence Immunity	Meet the IEC61000-4-4 and GB/T 17626.4 standard : Noise voltage amplitude 1KVP-P , pulse width 10us, period 0.3 s, edge time 5ns , duration 1min.		

## Output



Item	Relay Output	Transistor Output
Output Mode	--	NPN
Input Power Supply	DC 24V	DC 24V
Output Circuit	<AC 250V or <DC 30V	DC 5~30V
COM Port Current	--	<0.1mA ( DC30V )
Insulation	Mechanistic	Optical Coupling
Leak current	--	0.1mA/DC30V
Min.Load	--	DC 5V2mA
Max.Load	Resistive	2A point 8A COM port
	Inductive	80VA
	General	100W
ResponseTime	ON	<0.2ms
	OFF	<10ms (Pulse out put terminal: ~5us)

# PLC SPECIFICATIONS

## AC Power Supply



Item	LX3V(P/E/M)-0806M/1208M/1212M/1412M	LX3V(P/E/M)1616M/2416M/3624M
Voltage	AC 85~265V 50~60HZ	
Power Outage Time	10ms	
Rush Current	<15A 5ms/AC 100V;<30A 5ms/AC 200V	
Power Fuse	250V 3.15A	250V 3.15A
Power Consumption	<35W	<60W
Power Output	DC 24V 850mA	DC 24V 700mA

## DC Power Supply



Item	LX3V/LX3VP/LX3VE/LX3VM PLC
Power Supply	DC 24V±10%
Power Outage Time	10ms
Power Fuse	250V 3.15A
Rush Current	<15A 1ms/DC 24V
Impact Current	<30W